

CAMEL

Bartoli Design / 2015



IT Camel è un sistema di sedute dalle linee morbide e sobrie e dal carattere eclettico, adatto a situazioni diverse. La scocca, in polipropilene, può essere abbinata a differenti basi e accessori, ed è disponibile anche in soluzioni su barra, ideali per sale d'attesa e spazi di transito.

EN An eclectic collection of seating with delicate soft designed lines, comfortable in a variety of applications. The shell, in polypropylene, is combined with numerous bases and multiple seating for meeting, dining or public waiting environments.

FR Camel est une gamme de sièges aux lignes douces et sobres, qui s'adaptent à tous les contextes. La coque, en polypropylène, se marie avec un grand nombre de piétements et d'accessoires. Camel peut également être associé avec un système modulable d'assises sur poutre parfait pour les salles d'attente et les lieux de passage.

DE Camel ist eine Stuhlreihe mit weicher und klarer Linienführung, bequem in jeder Situation. Die Schale, aus Polypropylen, kann mit verschiedenen Gestellen und Accessoires kombiniert werden. Verfügbar auch als Bank, Ideal für Wartebereiche und Aufenthaltsräume. Eine vielfältige Serie, für den formellen und auch informellen Einsatzbereich.



Awards:
Golden Key Award
Belgrade Furniture Fair

Finiture / Finishes / Finitions / Ausführungen

Polipropilene / Polypropylene / Polypropylène / Kunststoff

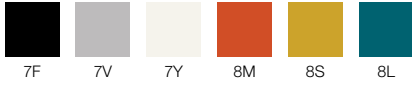

Struttura / Frame / Structure / Gestell

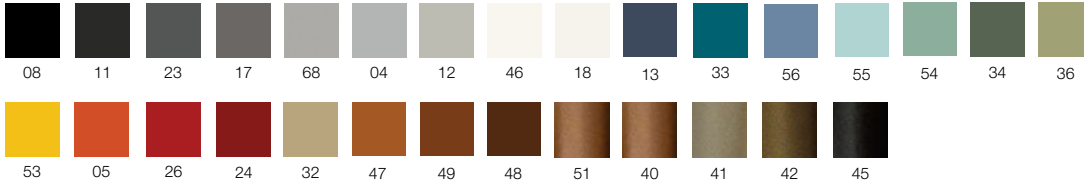

Struttura cromata / Chromed frame / Structure chromée / Gestell Verchromt



02

Legno / Wood / Bois / Holz



FA 02 FG 07

		Accessori_Accessories Accessoires_Zubehör		
C0514 Kart	 	Carrello universale Universal trolley Chariot universel Transportwagen	14 Kg	1 pc / 0,50 m3 14 kg

CAMEL

Bartoli Design / 2015

Scocca: polipropilene espanso riciclabile con finitura testurizzata. Se impilabile, la scocca è provvista di carter di protezione in polipropilene sotto al sedile.

Strutture disponibili:

VERNICIATE O CROMATE

- base a 4 gambe, per sedia in tubo di acciaio Ø 14 mm impilabile, con o senza braccioli.
- base slitta, per sedia, con o senza braccioli, impilabile in tondino d'acciaio Ø 12 mm.
- base impilabile a slitta H. 63 cm/75 cm in tubo d'acciaio Ø 16 mm.

VERNICIATE

- base piramidale per sedie e sgabelli in tubo conico d'acciaio.
- seduta su barra con trave in legno e basamento in tubo d'acciaio Ø 30 mm.

VERNICIATE E SPAZZOLATE

- base girevole in fusione di alluminio con peidini o ruote autofrenanti.

LEGNO

- base a trespolo in legno di faggio, con telaio in metallo verniciato a polveri epossidiche.

Braccioli: polipropilene nero per la scocca nera, grigio per tutti gli altri colori.

Piedini: materiale termoplastico.

Pianetto di servizio per la seduta su barra: laminato HPL bianco.

Shell: recyclable expanded polypropylene with textured finish. If stackable, the shell is equipped with a polypropylene protective cover under the seat.

Structures available:

POWDER COATED OR CHROMED FINISH

- 4-legged stackable base, for chair, in Ø14 mm steel tube, with or without armrests.
- stacking sled chair with or without armrests - in steel rod Ø 12 mm
- stacking sled stool H. 63 cm/75 cm in steel tube Ø 16 mm.

POWDER COATED FINISH

- pyramidal base for chairs and stools in steel conical tube.
- modular wood beam seating with steel tube Ø 30 mm legs.

POWDER COATED OR BRUSHED FINISH

- 4 star, swivel base in die cast aluminium with thermoplastic feet or self-braking castors.

WOOD

- wood trestle base 4 solid beech legs. Seat frame: powder coated metal.

Armrests: in light grey polypropylene; black shells have black armrests.

Glides: thermoplastic material.

Table top/beam seating: HPL.

Coque: Polypropylène (PP) expansé recyclable avec finitions texturées. Si empilable, la coque est munie d'un carter de protection en polypropylène sous l'assise.

Structures disponibles:

ÉPOXY LAQUÉE OU CHROMÉE.

- base à 4 pieds empilable, pour chaise, en tube d'acier Ø 14 mm, avec ou sans accoudoirs.
- base traineau empilable, pour chaise, en tube d'acier Ø 12 mm, avec ou sans accoudoirs.
- Tabouret empilable base traineau H. 63 cm/75 cm tube d'acier Ø 16 mm.

ÉPOXY LAQUÉE

- base pyramidale pour chaises et tabourets en tube conique d'acier.
- Système modulable d'assises sur poutre Structure: poutre en bois et piétements en tube d'acier Ø 30 mm.

ÉPOXY LAQUÉE OU BROSSÉE

- base 4 branches, fonte d'aluminium. Base pivotante avec patins en matière thermoplastique ou avec roulettes auto-freinées.

BOIS

- piétement pyramidal en bois / hêtre. Cadre sous assises en métal laqué.

Accoudoirs: Polypropylène (PP) noir pour la coque noir et gris clair pour les coques dans des autres coloris.

Patins: matière thermoplastique.

Tablette/poutre: Stratifié HPL Ø 50 cm.

Sitzschale: aus recyclefähigem Polypropylen. Beim Stapeln ist die Karosserie mit einer Schutzhaube aus Polypropylen unter dem Sitz versehen.

Gestell verfügbar:

EPOXYDLACKIERT ODER VERCHROMT

- 4-beiniges Stapelgestell, für Stuhl, aus Ø 14 mm Stahlrohr, mit oder ohne Armlehnen.
- Stuhl mit oder ohne Armlehnen auf stapelbar Kufengestell, aus Stahlrohr Ø 12 mm
- Barhocker stapelbar Sitzhöhe H. 63 cm/75 cm. Kufengestell aus Stahlrohr Ø 16 mm.

EPOXYDLACKIERT

- Pyramidenbasis für Stühle und Hocker aus Metall im konischen Stahlrohr.
- Modulares System von Sitzschale auf Holzträgern Träger: Holz und Gestell aus Stahlrohr Ø 30 mm.

EPOXYDLACKIERT ODER GEBÜRSTET

- 4-Sternfuß, Drehfuß aus Aluminiumdruckguss. Erhältlich mit thermoplastischen Füßen oder mit selbstbremsenden Rollen

HOLZ

- pyramidenförmige Beine aus Buchenholz. Gestell aus epoxidbeschichtetem Metall.

Armaufflage: aus Polyethylen, Farbe Schwarz für Sitz-Schale Schwarz, Farbe Hell-Grau für alle andere Sitz-Schalen.

Gleiter: aus Kunststoff.

Ablageplatte: HPL.

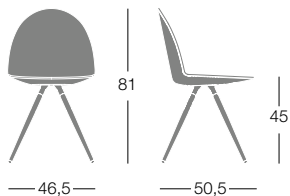

S0066

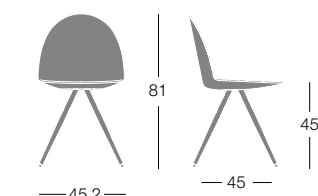

S0069

SEDIA SU TRESPOLO / CHAIR ON TRESTLE BASE / CHAISE AVEC PIÉTEMENT PYRAMIDAL / STUHL 4 BEIN

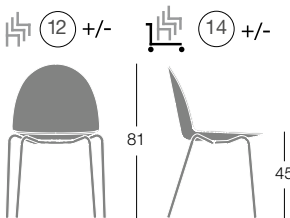

S0072

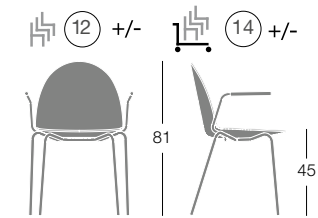

S0072 B

SEDIA IMPILABILE A 4 GAMBE / STACKING CHAIR 4 LEGS / CHAISE EMPILABLE 4 PIEDS / STUHL 4 BEIN STAPELBAR

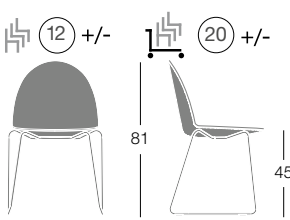

S0075

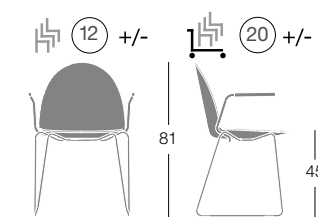

S0075 B

SEDIA IMPILABILE A SLITTA / STACKING SLED CHAIR / CHAISE EMPILABLE BASE TRINEAU / STUHL KUFENGESTELL STAPELBAR

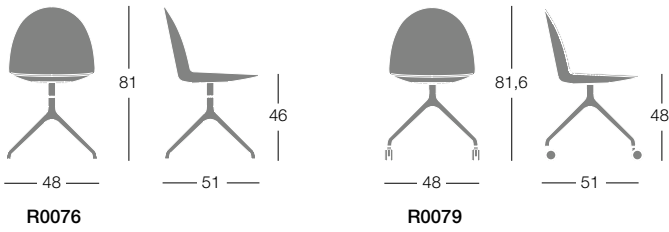

SEDIA A 4 RAZZE / CHAIR ON 4 STAR BASE / CHAISE, BASE 4 BRANCHES / STUHL AUF 4 FUSSGESTELL

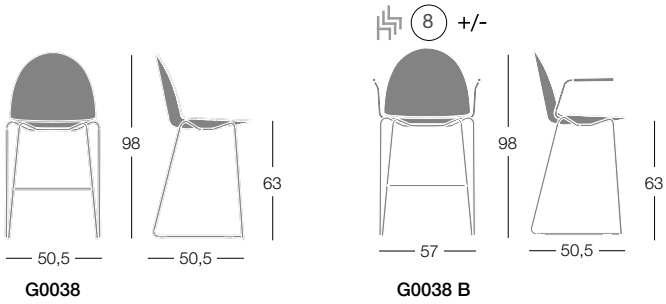

SGABELLO IMPILABILE A SLITTA H. 63 CM / STACKING SLED STOOL H. 63 CM / TABOURET EMPILABLE BASE TRINEAU H. 63 CM / BARHOCKER STAPELBAR SITZHÖHE H. 63 CM

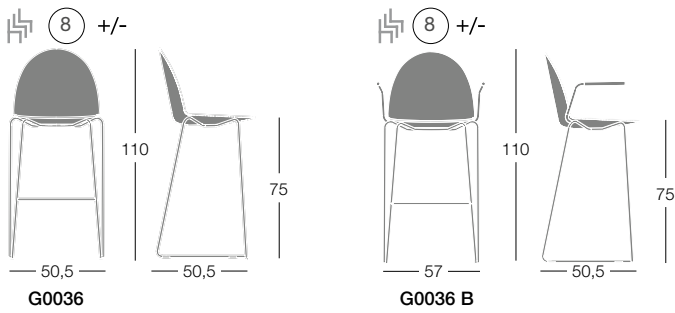

SGABELLO IMPILABILE A SLITTA H. 75 CM / STACKING SLED STOOL H. 75 CM / TABOURET EMPILABLE BASE TRINEAU H. 75 CM / BARHOCKER STAPELBAR SITZHÖHE H. 75 CM

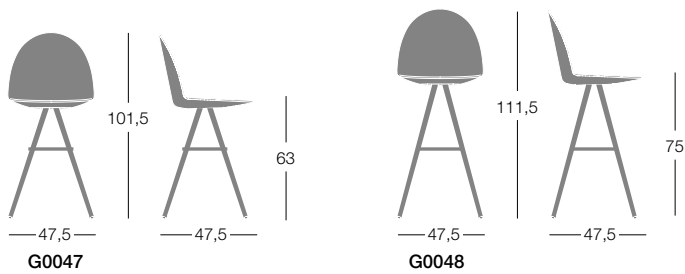

SGABELLO SU TRESPOLO IN METALLO / STOOL ON TRESTLE BASE / TABOURET BASE PYRAMIDALE EN MÉTAL / BARHOCKER SITZHÖHE

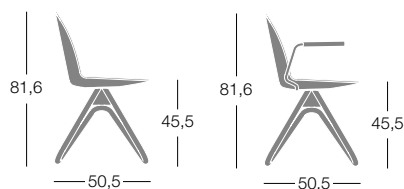
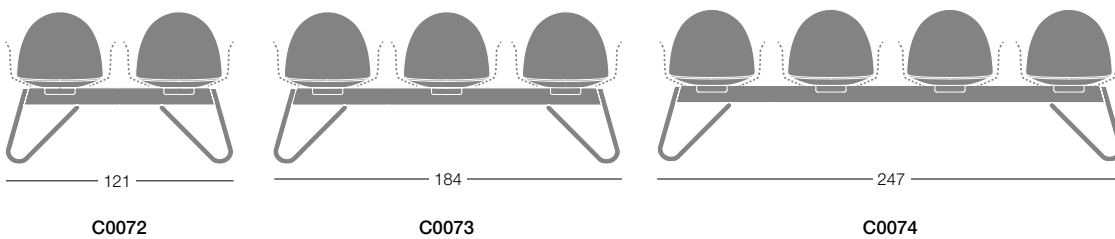

SEDUTA SU BARRA / MODULAR BEAM SEATING / SYSTÈME MODULABLE D'ASSISES SUR POUTRE / MODULARSYSTEM VON SITZSCHALE AUF HOLZTRÄGERN

CAMEL

Bartoli Design / 2015

S0066 Trespolo in faggio

S0069 Trespolo in metallo

S0066 Wooden trestle base

S0069 Metal trestle base

S0066 Piétement pyramidal en bois

S0069 Piétement pyramidal en métal

S0066 4 Beine Buchenholz

S0069 4 Beine Stahlrohr Konisch



S0066



S0069

Finiture_Finishes_Finitions_Ausführungen

ART.	Struttura_Frame Structure_Gestell	Polipropilene_Polypropylene_Polypropylène_Kunststoff	Kg	
S0066	Faggio_Beech Hêtre_Buchenholz		6,7 Kg	1 pc / 47x53x83 cm 0.21 m3 / 9,2 kg
S0069	verniciata_powder coated laquée_Lackiert		7,4 kg	1 pc / 53x48x84 cm 0.21 m3 / 9 kg



Art. S0069 Test di resistenza_Resistance tests_Tests officiels de résistance_Wiederstan: EN _ ANSI-BIFMA

Dimensioni_Dimensions_Dimensions_Abmessungen

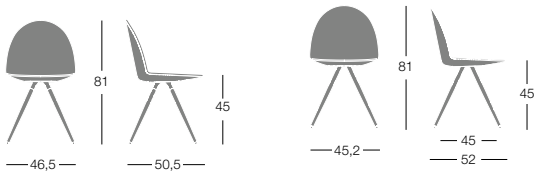

S0066

S0069



S0072 4 gambe impilabile
 S0072 B 4 gambe impilabile con braccioli
 S0075 Slitta impilabile
 S0075 B Slitta impilabile con braccioli

S0072 Stackable 4 legs
 S0072 B Stackable 4 legs with armrests
 S0075 Stackable sled base
 S0075 B Stackable sled base with armrests

S0072 Empilable 4 pieds
 S0072 B Empilable 4 pieds avec accoudoirs
 S0075 Empilable base traineau
 S0075 B Empilable base traineau avec accoudoirs

S0072 4 Beine stapelbar
 S0072 B Armlehnstuhl 4 Beine stapelbar
 S0075 Kufengestell stapelbar
 S0075 B Armlehnstuhl Kufengestell stapelbar



Finiture_Finishes_Finitions_Ausführungen

ART.	Struttura_Frame Structure_Gestell	Polipropilene_Polypropylene_Polypropylène_Kunststoff	Kg	
S0072	verniciata_powder coated laquée_Lackiert		6,8 kg	2 pcs / 53x57x89 cm 0.27 m3 / 16,1 kg
	cromata_chromed chromée_Verchromt			
S0072 B	verniciata_powder coated laquée_Lackiert		7,9 kg	2 pcs / 59x57x89 cm 0.30 m3 / 18,8 kg
	cromata_chromed chromée_Verchromt			
S0075	verniciata_powder coated laquée_Lackiert		8 kg	2 pcs / 54x57x89 cm 0.27 m3 / 18,5 kg
	cromata_chromed chromée_Verchromt			
S0075 B	verniciata_powder coated laquée_Lackiert		9,6 kg	2 pcs / 59x57x89 cm 0.30 m3 / 22,2 kg
	cromata_chromed chromée_Verchromt			



Art. S0072 - S0075 Test di resistenza_Resistance tests_Tests officiels de résistance_Widerstandstest: ANSI-BIFMA

Dimensioni_Dimensions_Dimensions_Abmessungen

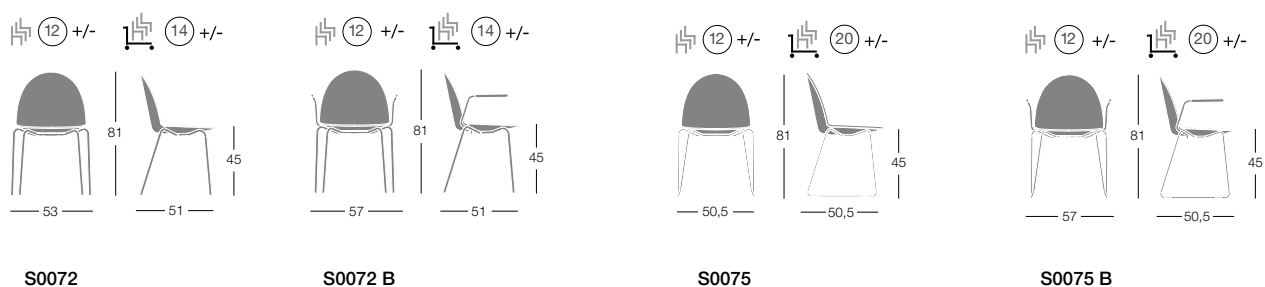

S0072

S0072 B

S0075

S0075 B

CAMEL

Bartoli Design / 2015

R0076 4 Razze girevole con piedini

R0079 4 Razze girevole con ruote autofrenanti

R0076 4 Star base with thermoplastic feet

R0079 4 Star base with self braking castors

R0076 4 Branches avec patins

R0079 4 Branches avec roulettes

R0076 Drehbares Fussgestell mit Gleitern

R0079 Drehbares Fussgestell mit Rollen



R0076



R0079

Finiture_Finishes_Finitions_Ausführungen

ART.	Struttura_Frame Structure_Gestell	Polipropilene_Polypropylene_Polypropylène_Kunststoff	Kg	
R0076	verniciata_powder coated laquée_Lackiert		8,2 kg	1 pc / 50x50x84,5 cm 0,21 m3 / 10,7 Kg
	spazzolata lucido_polished brushed poli-brossée_gébürstet			
R0079	verniciata_powder coated laquée_Lackiert		7,95 kg	1 pc / 50x50x84,5 cm 0,21 m3 / 10,4 Kg
	spazzolata lucido_polished brushed poli-brossée_gébürstet			

Dimensioni_Dimensions_Dimensions_Abmessungen

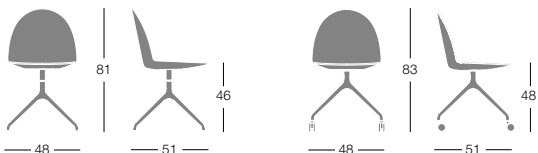

R0076

R0079



G0038 Sgabello impilabile a slitta H.63 cm
 G0038 B Sgabello impilabile slitta H.63 cm con braccioli
 G0036 Sgabello impilabile a slitta H.75 cm
 G0036 B Sgabello impilabile a slitta H.75 cm con braccioli

G0038 Stackable sled stool H.63 cm
 G0038 B Stackable sled stool H.63 cm with armrests
 G0036 Stackable sled stool H.75 cm
 G0036 B Stackable sled stool H.75 cm with armrests

G0038 Tabouret empilable base traineau H.63 cm
 G0038 B Tabouret empilable base traineau H.63 cm avec accoudoirs
 G0036 Tabouret empilable base traineau H.75 cm
 G0036 B Tabouret empilable base traineau H.75 cm avec accoudoirs

G0038 Barhocker stapelbar H. 63 cm
 G0038 B Barhocker stapelbar mit Kufengestell und Armlehne H. 63 cm
 G0036 Barhocker stapelbar H. 75 cm
 G0036 B Barhocker stapelbar mit Kufengestell und Armlehne H. 75 cm



G0038



G0036



G0036 B

Finiture_Finishes_Finitions_Ausführungen

ART.	Struttura_Frame Structure_Gestell	Polipropilene_Polypropylene_Polypropylène_Kunststoff	Kg	
G0038 H.63 cm	verniciata_powder coated laquée_Lackiert		8,4 kg	2 pcs/ 63x54x105 cm 0.35 m3/ 19,8 kg
	cromata_chromed chromée_Verchromt			
G0038 B H.63 cm	verniciata_powder coated laquée_Lackiert		9 kg	2 pcs/ 63x59x105 cm 0.39 m3/ 21 kg
	cromata_chromed chromée_Verchromt			
G0036 H.75 cm	verniciata_powder coated laquée_Lackiert		8,9 kg	2 pcs/ 63x54x118 cm 0.40 m3/ 20,8 kg
	cromata_chromed chromée_Verchromt			
G0036 B H.75 cm	verniciata_powder coated laquée_Lackiert		10,5 kg	2 pcs/ 63x59x118 cm 0.44 m3/ 24 kg
	cromata_chromed chromée_Verchromt			

Dimensioni_Dimensions_Dimensions_Abmessungen

8 +/-

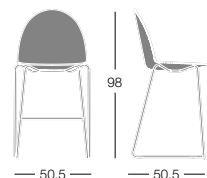

G0038

8 +/-

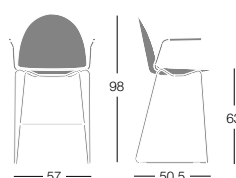

G0038 B

8 +/-

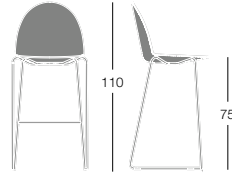

G0036

8 +/-

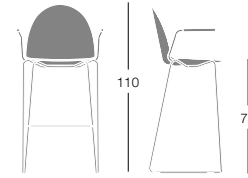

G0036 B

CAMEL

Bartoli Design / 2015

G0047 Sgabello su trespolo in metallo H.63 cm
 G0048 Sgabello su trespolo in metallo H.75 cm

G0047 Metal trestle base stool H.63 cm
 G0048 Metal trestle base stool H.75 cm

G0047 Tabouret base pyramidale en métal H.63 cm
 G0048 Tabouret base pyramidale en métal H.75 cm

G0047 4 Beine Barhocker Stahlrohr Konisch H.63 cm
 G0048 4 Beine Barhocker Stahlrohr Konisch H.75 cm



G0047-G0048

Finiture_Finishes_Finitions_Ausführungen

ART.	Struttura_Frame Structure_Gestell	Polipropilene_Polypropylene_Polypropylène_Kunststoff	Kg	
G0047 H.63 cm	verniciata_powder coated laquée_Lackiert		6,9 kg	1 pc/ 51X51X104 cm 0.27 m3/ 9,6 kg
G0048 H.75 cm	verniciata_powder coated laquée_Lackiert		7 kg	1 pc/ 51X51X116 cm 0.3 m3/ 9 kg

Dimensioni_Dimensions_Dimensions_Abmessungen

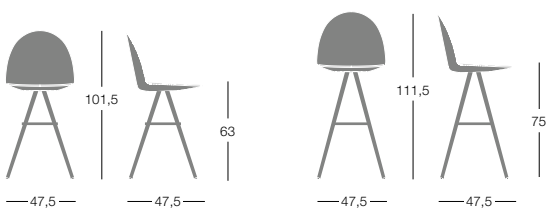

G0047

G0048

C0076 Seduta / C0082 Seduta con braccioli
 C0072 Barra 2 posti / C0073 Barra 3 posti / C0074 Barra 4 posti
 PHPT050 BI Tavolino

C0076 Seat / C0082 Seat with 2 armrests
 C0072 Beam 2 seats / C0073 Beam 3 seats / C0074 Beam 4 seats
 PHPT050 BI table top

C0076 Assise / C0082 Assise avec 2 accoudoirs
 C0072 Poutre 2 assises / C0073 Poutre 3 assises / C0074 Poutre 4 assises
 PHPT050 BI tablette

C0076 Schale / C0082 Schale mit Armlehnen
 C0072 Träger 2 Sitzer Module / C0073 Träger 3 Sitzer Module / C0074 Träger 2 Sitzer Module
 PHPT050 BI Ablage



C0073

Finiture_Finishes_Finitions_Ausführungen

ART.	Struttura_Frame Structure_Gestell	Polipropilene_Polypropylene_Polypropylène_Kunststoff	Kg	
C0076	verniciata_powder coated laquée_Lackiert		13 kg	4 pcs/ 65,5X38X50 cm 0.12 m3 / 15,8 Kg
C0082	verniciata_powder coated laquée_Lackiert		19 kg	4 pcs/ 65,5X38X50 cm 0.12 m3 / 22,2 Kg

Laminato HPL_HPL laminated_Stratifié HPL_HPL-Laminat

PHPT050 BI	tavolino_table top tablette_Ablage			
------------	---------------------------------------	--	--	--

Verniciata_Stained_Laquée_Lackiert

			Kg	
C0072 121 cm	Barra 2 posti Beam 2 seats Poutre 2 assises Träger 2 Sitz		14,9 kg	1 pc/ 53X124X45 cm 0.3 m3/ 18,4 Kg
C0073 184 cm	Barra 3 posti Beam 3 seats Poutre 3 assises Träger 3 Sitz		19,5 kg	1 pc/ 53X187X45 cm 0.45 m3/ 23,5 Kg
C0074 247 cm	Barra 4 posti Beam 4 seats Poutre 4 assises Träger 4 Sitz		23,8 kg	1 pc/ 53X250X45 cm 0.6 m3/ 28,3 Kg

Accessori_Accessories_Accessoires_Zubehör

Ancoraggio a terra per n.2 piedi, in diagonale Floor anchorage (two legs in diagonal pattern) Système de fixation au sol prévue sur deux pieds en diagonale Bodenverankerung 2 Stück in der Diagonale	45
--	----

Dimensioni_Dimensions_Dimensions_Abmessungen

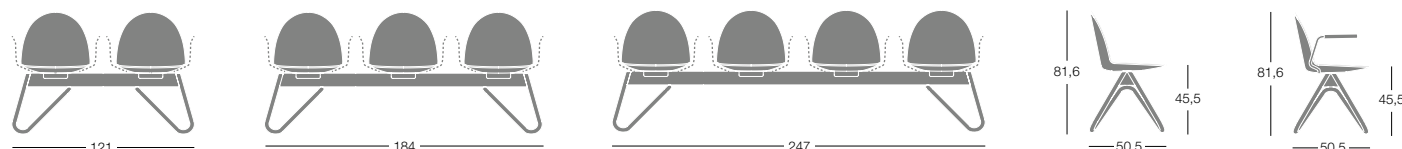

C0072

C0073

C0074